

Dk-Lok USA

161 West I-65 Service Road

Mobile, AL 36608

Phone: (251) 472-9580

Fax: (251) 450-0962 or (800) 287-8186

info@dklokusa.com

Item # V46A-F-6N-S, V46A Series Hex. Body Needle Valves

Features

- **Packing bolt** permits packing adjustment externally.
- **Chevron PTFE packing** design provides far improved sealing integrity.
- **Packing** below stem threads is to isolate **threads** from system fluid and lubricant washout.
- **Non-rotating** stem tip at closure for long-life and leak-tight shutoff.
- **Lock plate** ensures the valve fastened to the body.
- **NACE MR0175/ISO 15156-3** applicable.

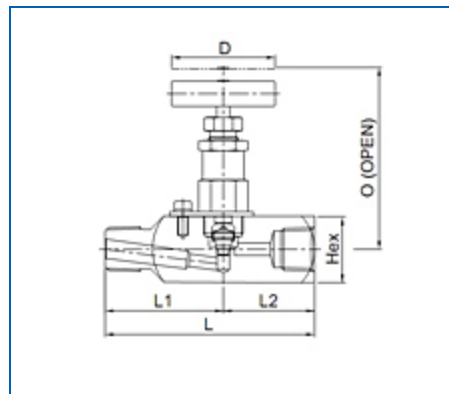

[Specifications](#) | [Dimensions](#)

Specifications

Series	Hex Body Needle Valves
End Connection	Female NPT to Female NPT
Size Inlet x Outlet	3/8" Female NPT x 3/8" Female NPT
Body Material	Stainless Steel
Packing Material	PTFE
Temperature Rating	-54 to 232°C (-65 to 450°F)

Pressure Rating at 38 °C (100 °F)	689 bar (10000 psig)
--	----------------------

Sour Gas Valve	Optional
-----------------------	----------

Dimensions

Orifice	4.7
Cv	0.83
L	76.2 mm
MAX OPEN	67.2 mm
L1	44.4 mm
Hex	31.8 mm
D	45 mm